

BASIC DIE SETS

HEPCO Model 3100-1

****REPLACES 3000-2****
Dies Interchangeable
for Either Version

3204 Series

Flush Mount Lock-In Die Sets

The 3204 Series provides direct mounting of the component on the PCB while providing a lock-in. This die works best with flat-bottomed components such as CK06 or electrolytic caps.

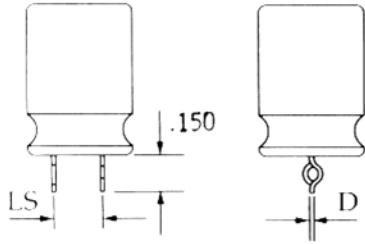

Die #	LS	D
3204-2-1	.100" - .550"	.018" - .022"
3204-2-2	.150" - .550"	.023" - .028"

3205 Series

Capacitor Spread Die Sets

The 3205 Series spreads the leads to a desired spacing. Each die has a fixed "Spread To" dimension. For each "Starting From" dimension, a different cover plate is required. Dies include one (1) cover plate.

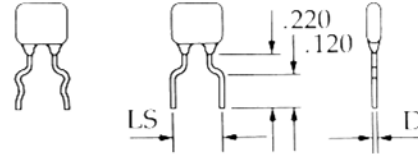

Die #	LS	D
3205-2-1	.200" Lock-In	.018" - .020"
*3205-1-2	.200" No Lock	.018" - .020"
3205-1-3	.250" No Lock	.018" - .020"
3205-1-4	.300" No Lock	.023" - .025"

Extended Form Capacitor Die Sets

3207 Series

Capacitor Stand-Off Die Sets

The 3207 Series provides an extended-form to keep the component from "walking" into the PCB hole. The die retains the opposing loop versatility and stability on the PCB. An extended lead spacing and lead diameter range are also featured. The 3201 Series is for Larger Diameter Leads.

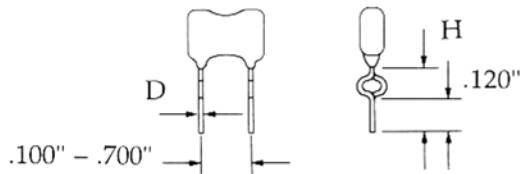

Die #	LS	D	H
*3207-1-1	.100" - .700"	.015" - .025"	.220"
*3207-1-2	.100" - .700"	.023" - .032"	.270"
3201-1-4	.200" - 1.25"	.030" - .037"	.270"
3201-1-5	.200" - 1.25"	.040" - .047"	.270"

3208 Series

Capacitor Stand-Off / Lock-In Die Sets

The 3208 Series also provides an extended-form to keep the component from "walking" into the PCB hole. This die features a wide range of lead spacings and lead diameters. The double lock-in form enables a smoother yet stronger snap into the PCB.

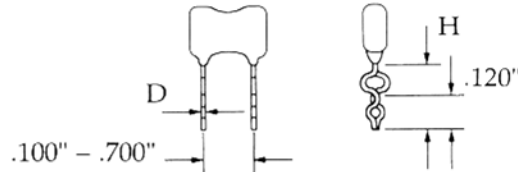

Die #	LS	D	H
*3208-1-1	.100" - .700"	.015" - .025"	.220"
*3208-1-2	.100" - .700"	.023" - .032"	.270"

Note: * Reflects Standard Die Sets – Normally Kept In Stock for Immediate Delivery

Dimensions and Lengths Shown Above Reflect HEPCO Standards Which Are Common Throughout the Industry.

If You Have Other Requirements, However, Please Submit Your Specifications for Prompt Quotation.

BASIC DIE SETS

HEPCO Models 3000-2/3100-1

Transistor Die Sets

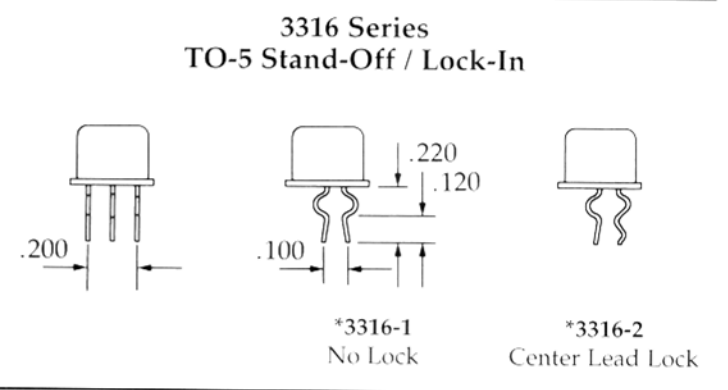
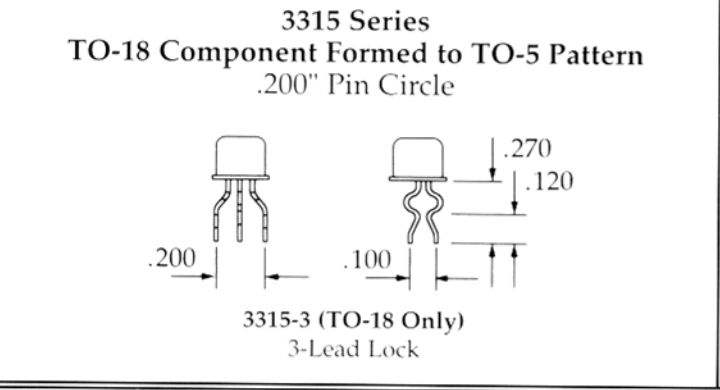
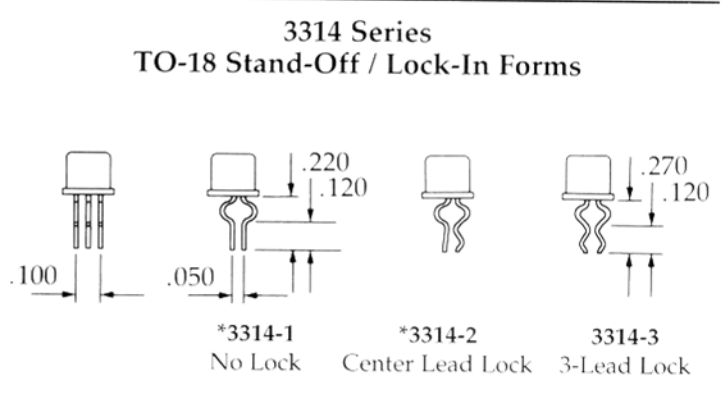
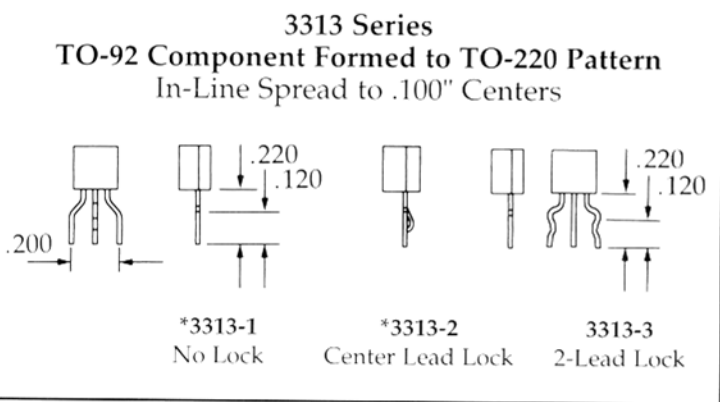
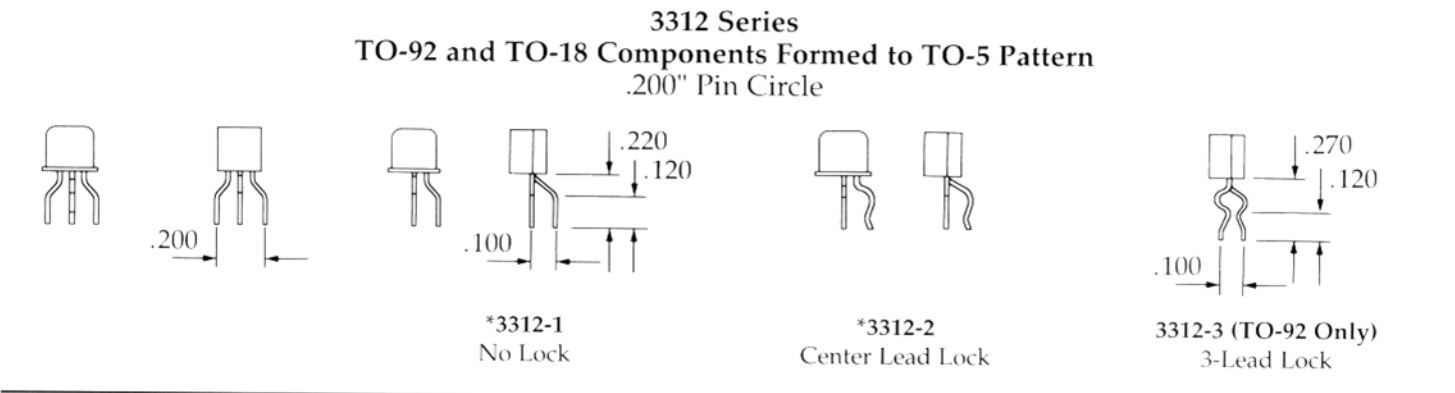
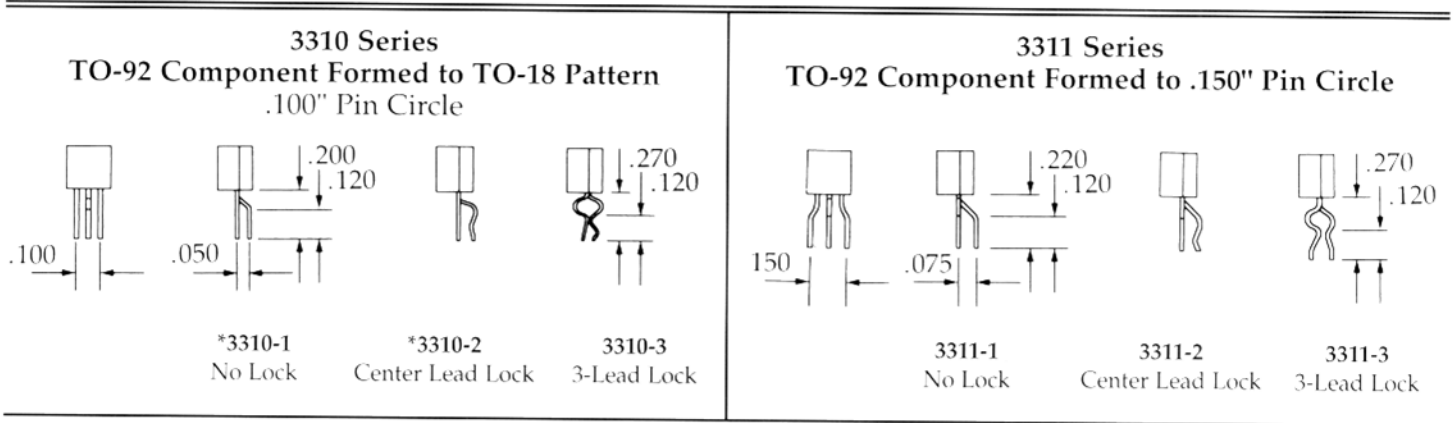

Note: * Reflects Standard Die Sets – Normally Kept In Stock for Immediate Delivery
 Dimensions and Lengths Shown Above Reflect HEPSCO Standards Which Are Common Throughout the Industry.
 If You Have Other Requirements, However, Please Submit Your Specifications for Prompt Quotation.

BASIC DIE SETS

HEPCO Model 3000-2/3100-1

Lead Shear Die Sets

*3602-1-1 Standard Pattern Lead Shear Die Set

Standard shear pattern is designed to handle most common transistors, varistors and capacitors. Slot adds even more flexibility. Standard cut length is .120". Other lengths available to customer specification. Additional charges may apply to special cut lengths.

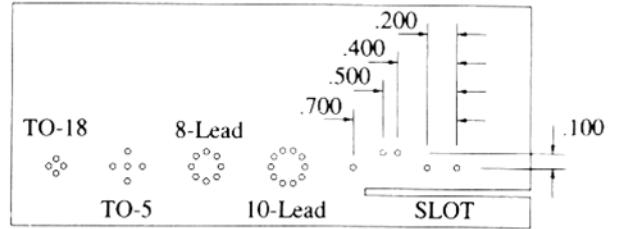

*3602-1-2 Grid Pattern Lead Shear Die Set

Standard grid die allows trimming of a variety of components from capacitors and transistors to connectors. Standard cut length is .120" – Other lengths available to customer specification. Additional charges may apply to special cut lengths.

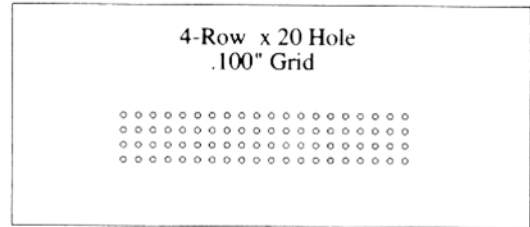

3602-1-3 Lead Shear Die to Customer Specification

Hole pattern per customer specification. Trim Length also to be specified by customer. Usable die area is 2.8" by .500". Price determined by number of holes and cut length specified.

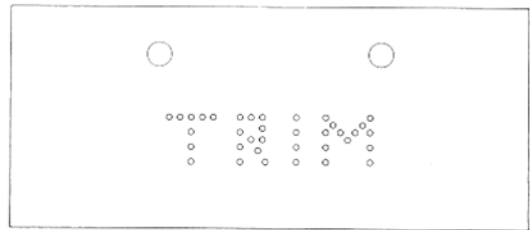

Axial Die Sets

A large variety of custom axial dies are available for the Model 3000-2. The dies clamp between the component body and the bend and provide a clean trim and form. Each die is built for a fixed dimension and specific lead diameter so results are extremely accurate and repeatable.

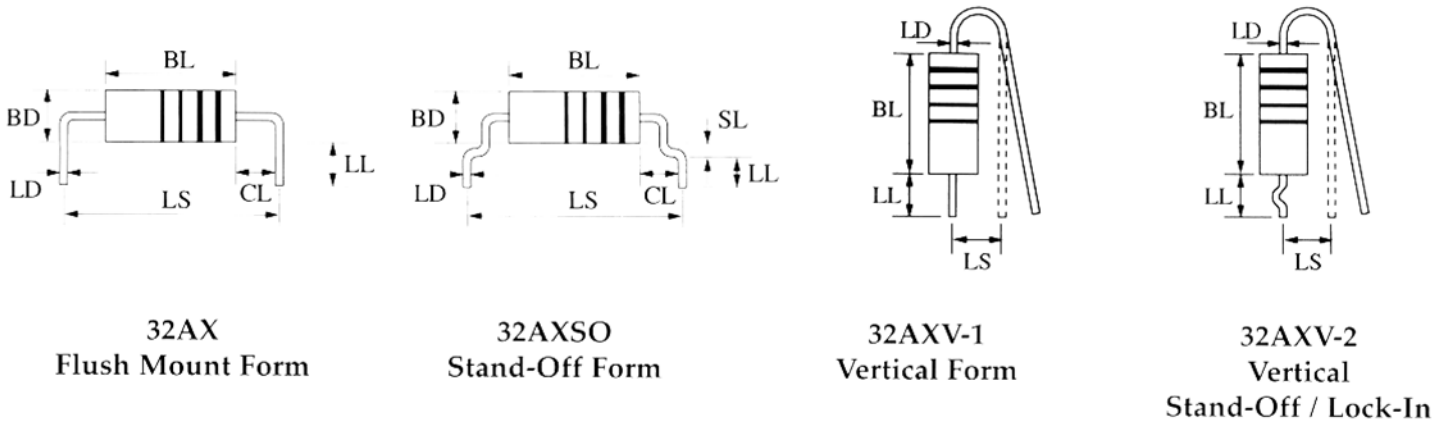

Note: * Reflects Standard Die Sets – Normally Kept In Stock for Immediate Delivery

Dimensions and Lengths Shown Above Reflect HEPSCO Standards Which Are Common Throughout the Industry.

If You Have Other Requirements, However, Please Submit Your Specifications for Prompt Quotation.

SMT DIE SETS

HEPCO Model 3000-2/3100-1

DIP Gull-Wing Die Set

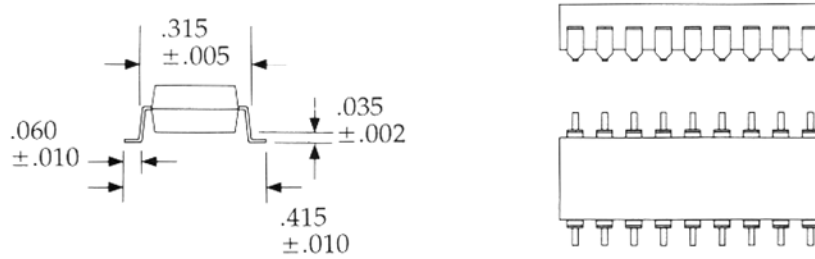

The die set turns standard .300" DIP ICs to 18-pins to a gull-wing form per the above sketch. The die trims and forms the leads in a single operation. The leads are kept co-planar to $\pm.002$ ".

Style 7 Horizontal In-Line Lap



Dies are available for an accurate, clean SMT lap joint form on a variety of components. Standard TO-transistor dies are available, and custom dies for other components are available.

Flat Pack / Quad Pack Gull-Wing

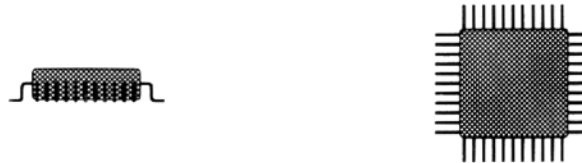

Dies are made to customer specifications. Components are formed and trimmed one side at a time. Locating blocks reference the component body accurately to enable $\pm.002$ " co-planarity.

Common Custom Forms

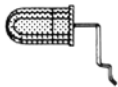

Horizontal Stand-Off Lock-In
Excellent for positioning LEDs, Hall Cells, Reed Switches, and for raising a component over another component.



Tall Stand-Off / Lock-In
Holds component specific height above the PCB.

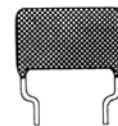

3206 Series
Capacitor reduction die set. Decreases component lead spacing to match PCB lead spacing. Creates stand-off and trims to length.

